

# CAVITY RESONATORS

## UHF 806 - 894 MHz

### ELECTRICAL SPECIFICATIONS

Model Number	6654/SBC1	6654/SBC3	6667/SBC3
Frequency Band (MHz)	806-894	806-894	806-894
Input Power-See Appl. Notes	100 W	100 W	200 W
Insertion Loss	See Application Notes on Page 45		
Attenuation	See Charts Below	See Charts Below	See Charts Below
Impedance	50 Ω	50 Ω	50 Ω
VSWR	1.5:1 or Better	1.5:1 or Better	1.5:1 or Better
Electrical Length	1/4 λ	3/4 λ	3/4 λ
Temp Range	- 22 to +140 °F - 30 to +60 °C	- 22 to +140 °F - 30 to +60 °C	- 22 to +140 °F - 30 to +60 °C

### MECHANICAL SPECIFICATIONS

Dim (d x w)		4" x 4"	4" x 4"	7" x 7"
Individual Cavity		102 x 102 mm	102 x 102 mm	178 x 178 mm
Dim (Height)	Inches	8" - 11"	14" - 16"	11" - 12 1/2"
Individual Cavity	Metric	204 - 280 mm	356 - 407 mm	280 - 318 mm
Connectors		N Female	N Female	N Female
Finish		EMR Gray	EMR Gray	EMR Gray
Ship Weight: Single		6 lbs. (2.8 kg.)	8 lbs. (3.7 kg.)	12 lbs. (5.5 kg.)
Dual		10 lbs. (4.6 kg.)	18 lbs. (8.2 kg.)	22 lbs. (10.0 kg.)
Triple		14 lbs. (6.4 kg.)	23 lbs. (10.5 kg.)	30 lbs. (13.7 kg.)



6654/SBC1-2



6654/SBC3



6667/SBC3

**BAND PASS**

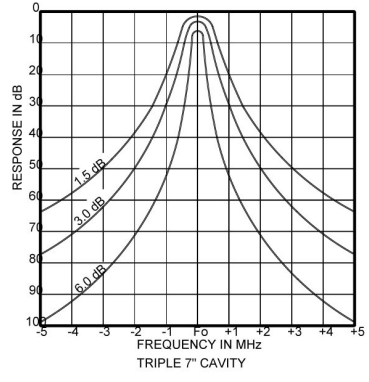
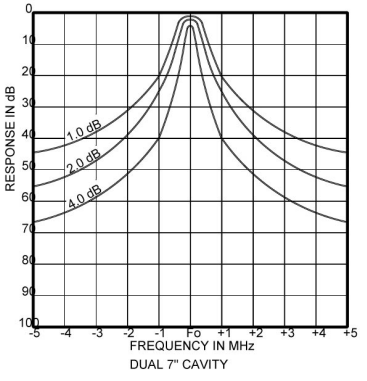
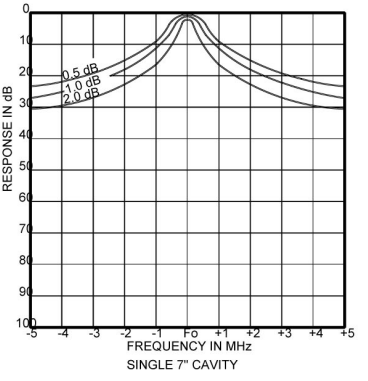
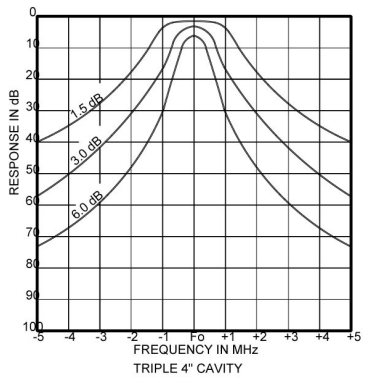
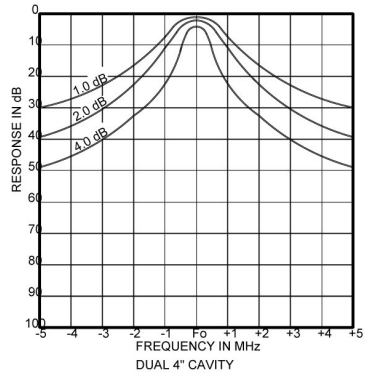
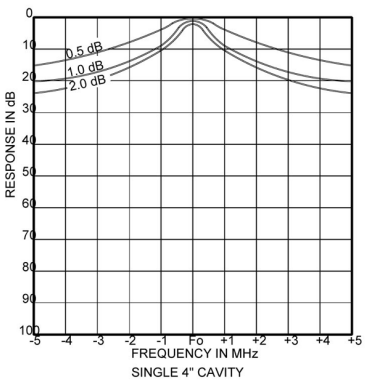

# CAVITY RESONATORS

## UHF 806 - 894 MHz

BAND PASS

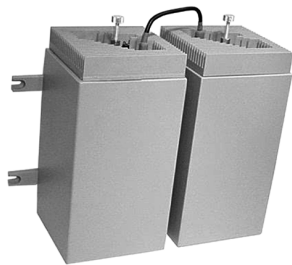

6677/SBC3H-2

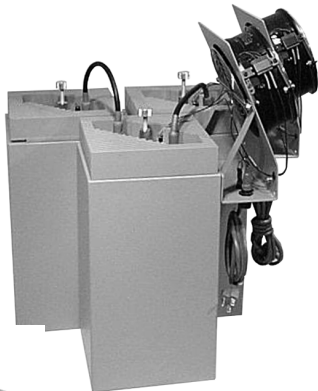

6677/SBC3HF-3



66610/SBC3

### ELECTRICAL SPECIFICATIONS

Model Number	6677/SBC3H	6677/SBC3HF	66610/SBC3
Frequency Band (MHz)	806-894	806-894	806-894
Input Power-See Appl. Notes	250 W	350 W	200 W
Insertion Loss	See Application Notes on Page 45		
Attenuation	See Charts Below	See Charts Below	See Charts Below
Impedance	50 Ω	50 Ω	50 Ω
VSWR	1.25:1 or Better	1.25:1 or Better	1.25:1 or Better
Electrical Length	3/4 λ	3/4 λ	3/4 λ
Temp Range	- 22 to +140 °F - 30 to +60 °C	- 22 to +140 °F - 30 to +60 °C	- 22 to +140 °F - 30 to +60 °C

### MECHANICAL SPECIFICATIONS

Dim (d x w)		7" x 7"	7" x 12"	10" x 10"
Individual Cavity		178 x 178 mm	178 x 305 mm	254 x 254 mm
Dim (Height)	Inches	14" - 16"	21"	14" - 17"
Individual Cavity	Metric	356 - 407 mm	534 mm	356 - 432 mm
Connectors		N Female	N Female	N Female
Finish		EMR Gray	EMR Gray	EMR Gray
Ship Weight: Single		15 lbs. (6.9 kg.)	18 lbs. (8.2 kg.)	16 lbs. (7.3 kg.)
Dual		24 lbs. (10.9 kg.)	34 lbs. (15.5 kg.)	Contact Factory
Triple		35 lbs. (15.9 kg.)	65 lbs. (29.5 kg.)	Contact Factory

